

Hyperfast Rectifier, 2 x 10 A FRED Pt™

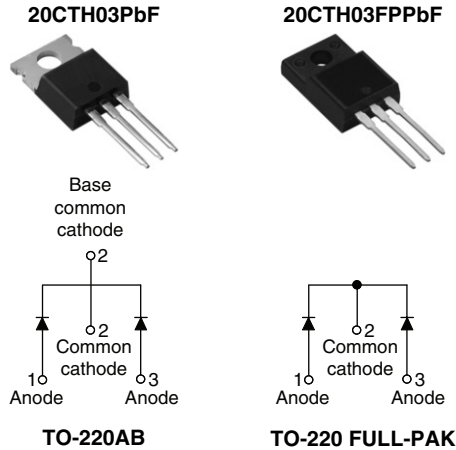

FEATURES

- Hyperfast recovery time
- Low forward voltage drop
- Low leakage current
- 175 °C operating junction temperature
- Fully isolated package ($V_{INS} = 2500 V_{RMS}$)
- Lead (Pb)-free ("PbF" suffix)
- TO-220 designed and qualified for AEC Q101 level
- TO-220FP designed and qualified for industrial level

RoHS*
COMPLIANT

DESCRIPTION/APPLICATIONS

300 V series are the state of the art hyperfast recovery rectifiers designed with optimized performance of forward voltage drop and hyperfast recovery time.

The planar structure and the platinum doped life time control, guarantee the best overall performance, ruggedness and reliability characteristics.

These devices are intended for use in the output rectification stage of SMPS, UPS, dc-to-dc converters as well as freewheeling diodes in low voltage inverters and chopper motor drives.

Their extremely optimized stored charge and low recovery current minimize the switching losses and reduce over dissipation in the switching element and snubbers.

PRODUCT SUMMARY

| | |
|--------------------|----------|
| t_{rr} (maximum) | 35 ns |
| $I_{F(AV)}$ | 2 x 10 A |
| V_R | 300 V |

ABSOLUTE MAXIMUM RATINGS

| PARAMETER | SYMBOL | TEST CONDITIONS | VALUES | UNITS |
|---|----------------|---|-------------|-------|
| Peak repetitive reverse voltage | V_{RRM} | | 300 | V |
| Average rectified forward current | $I_{F(AV)}$ | per diode $T_C = 160\text{ °C}$ | 10 | A |
| | | (FULL-PAK) per diode $T_C = 135\text{ °C}$ | 20 | |
| | | per device | | |
| Non-repetitive peak surge current | I_{FSM} | $T_J = 25\text{ °C}$ | 120 | |
| Operating junction and storage temperatures | T_J, T_{Stg} | | - 65 to 175 | °C |

ELECTRICAL SPECIFICATIONS ($T_J = 25\text{ °C}$ unless otherwise specified)

| PARAMETER | SYMBOL | TEST CONDITIONS | MIN. | TYP. | MAX. | UNITS |
|-------------------------------------|---------------|--|------|------|------|---------|
| Breakdown voltage, blocking voltage | V_{BR}, V_R | $I_R = 100\ \mu A$ | 300 | - | - | V |
| Forward voltage | V_F | $I_F = 10\text{ A}$ | - | 1.05 | 1.25 | |
| | | $I_F = 10\text{ A}, T_J = 125\text{ °C}$ | - | 0.85 | 0.95 | |
| Reverse leakage current | I_R | $V_R = V_R$ rated | - | - | 20 | μA |
| | | $T_J = 125\text{ °C}, V_R = V_R$ rated | - | 6 | 200 | |
| Junction capacitance | C_T | $V_R = 300\text{ V}$ | - | 30 | - | pF |
| Series inductance | L_S | Measured lead to lead 5 mm from package body | - | 8 | - | nH |

* Pb containing terminations are not RoHS compliant, exemptions may apply

20CTH03PbF/20CTH03FPPbF



Vishay High Power Products

Hyperfast Rectifier,
2 x 10 A FRED Pt™

| DYNAMIC RECOVERY CHARACTERISTICS ($T_C = 25\text{ }^\circ\text{C}$ unless otherwise specified) | | | | | | |
|--|-----------|---|------|------|------|-------|
| PARAMETER | SYMBOL | TEST CONDITIONS | MIN. | TYP. | MAX. | UNITS |
| Reverse recovery time | t_{rr} | $I_F = 1\text{ A}$, $di_F/dt = 50\text{ A}/\mu\text{s}$, $V_R = 30\text{ V}$ | - | - | 35 | ns |
| | | $I_F = 1\text{ A}$, $di_F/dt = 100\text{ A}/\mu\text{s}$, $V_R = 30\text{ V}$ | - | - | 30 | |
| | | $T_J = 25\text{ }^\circ\text{C}$ | - | 31 | - | |
| | | $T_J = 125\text{ }^\circ\text{C}$ | - | 42 | - | |
| Peak recovery current | I_{RRM} | $T_J = 25\text{ }^\circ\text{C}$ | - | 2.4 | - | A |
| | | $T_J = 125\text{ }^\circ\text{C}$ | - | 5.6 | - | |
| Reverse recovery charge | Q_{rr} | $T_J = 25\text{ }^\circ\text{C}$ | - | 36 | - | nC |
| | | $T_J = 125\text{ }^\circ\text{C}$ | - | 120 | - | |

| THERMAL - MECHANICAL SPECIFICATIONS | | | | | | |
|--|-------------------|--|-----------|------|------|---------------------------|
| PARAMETER | SYMBOL | TEST CONDITIONS | MIN. | TYP. | MAX. | UNITS |
| Maximum junction and storage temperature range | T_J , T_{Stg} | | - 65 | - | 175 | $^\circ\text{C}$ |
| Thermal resistance, _____ per diode junction to case (FULL-PAK) per diode | R_{thJC} | Mounting surface, flat, smooth and greased | - | - | 1.5 | $^\circ\text{C}/\text{W}$ |
| | | | - | - | 3.9 | |
| Marking device | | Case style TO-220AB | 20CTH03 | | | |
| | | Case style TO-220 FULL-PAK | 20CTH03FP | | | |

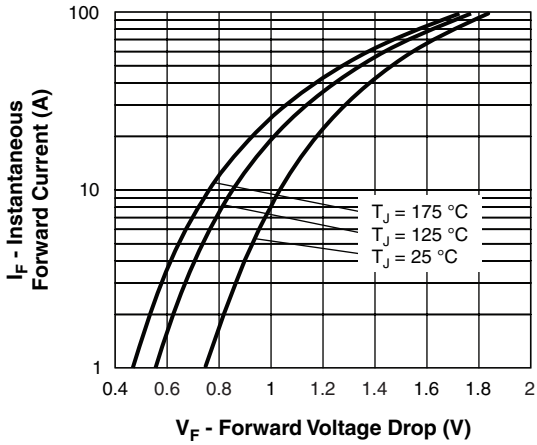

Fig. 1 - Typical Forward Voltage Drop Characteristics

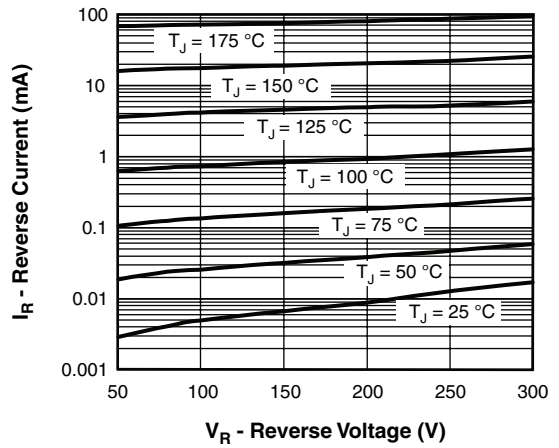

Fig. 2 - Typical Values of Reverse Current vs. Reverse Voltage

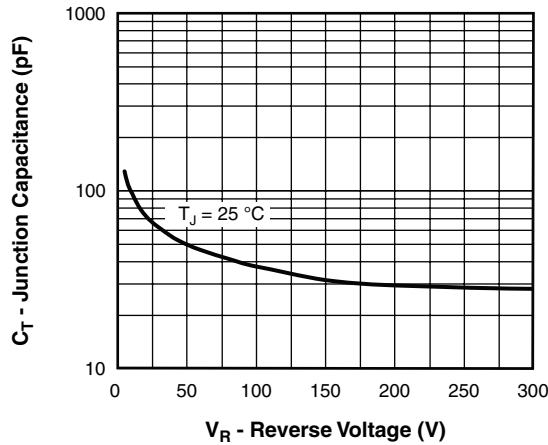

Fig. 3 - Typical Junction Capacitance vs. Reverse Voltage

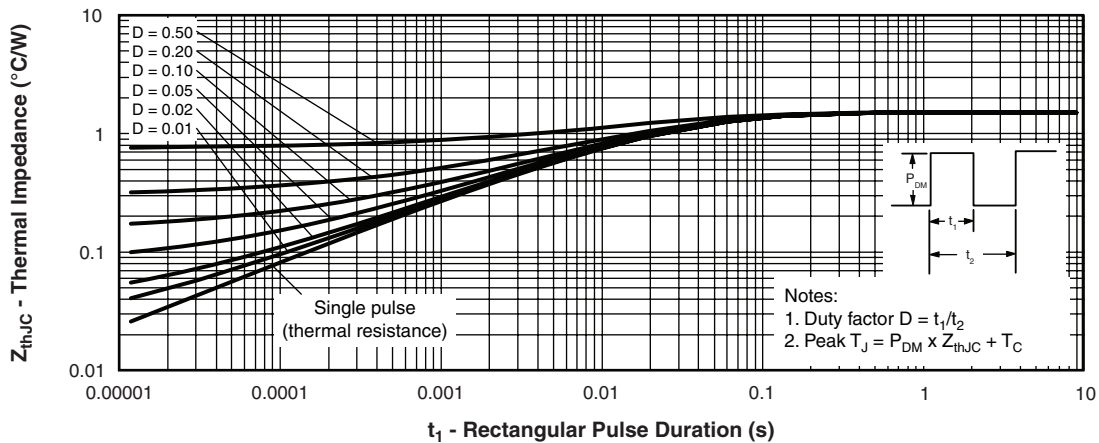

Fig. 4 - Maximum Thermal Impedance Z_{thJC} Characteristics

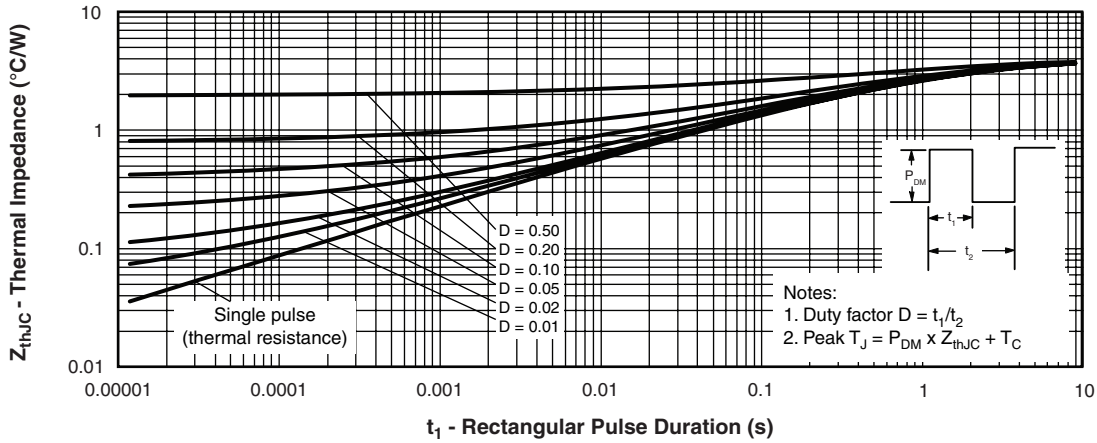

Fig. 5 - Maximum Thermal Impedance Z_{thJC} Characteristics (FULL-PAK)

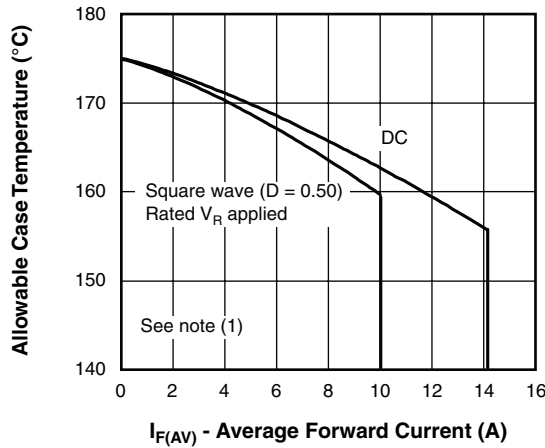

Fig. 6 - Maximum Allowable Case Temperature vs. Average Forward Current

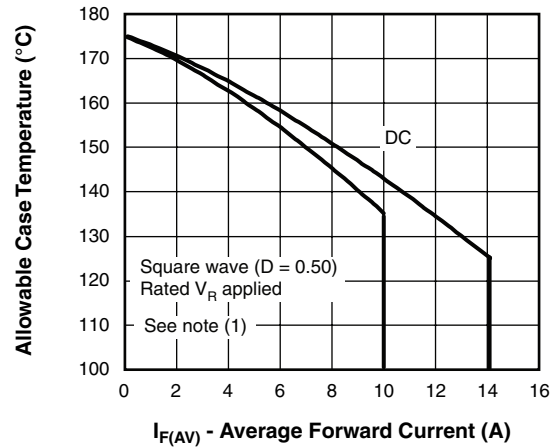

Fig. 7 - Maximum Allowable Case Temperature vs. Average Forward Current (FULL-PAK)

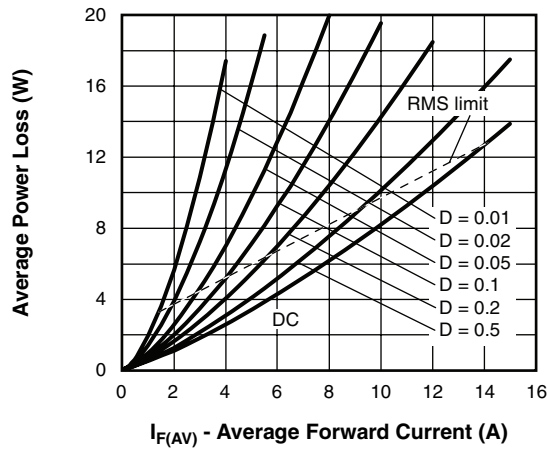

Fig. 8 - Forward Power Loss Characteristics

Note

- (1) Formula used: $T_C = T_J - (P_d + P_{d_{REV}}) \times R_{thJC}$;
- P_d = Forward power loss = $I_{F(AV)} \times V_{FM}$ at $(I_{F(AV)}/D)$ (see fig. 8);
- $P_{d_{REV}}$ = Inverse power loss = $V_{R1} \times I_R (1 - D)$; I_R at V_{R1} = Rated V_R

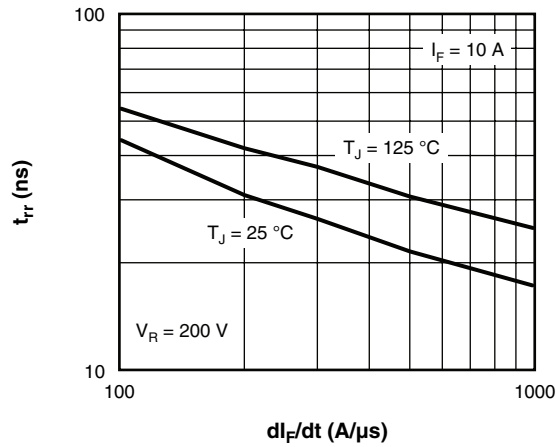

Fig. 9 - Typical Reverse Recovery Time vs. di_F/dt

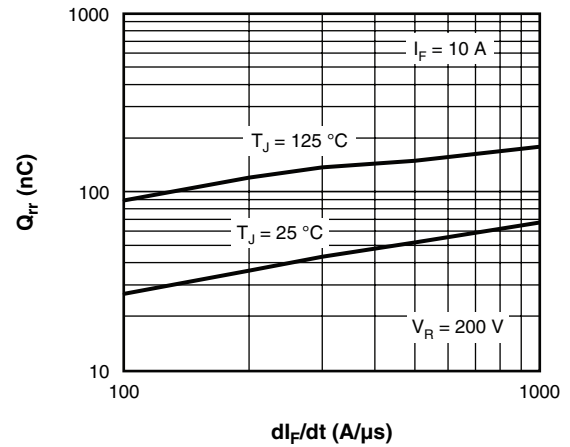

Fig. 10 - Typical Stored Charge vs. di_F/dt

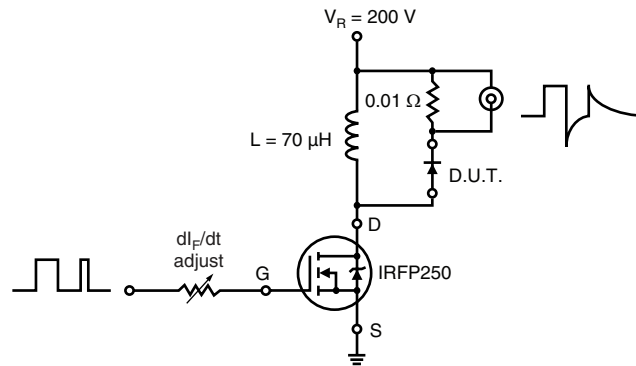
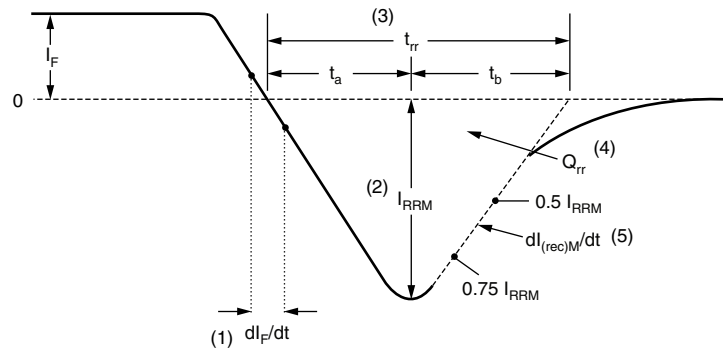

Fig. 11 - Reverse Recovery Parameter Test Circuit



(1) di_F/dt - rate of change of current through zero crossing

(2) I_{RRM} - peak reverse recovery current

(3) t_{rr} - reverse recovery time measured from zero crossing point of negative going I_F to point where a line passing through $0.75 I_{RRM}$ and $0.50 I_{RRM}$ extrapolated to zero current.

(4) Q_{rr} - area under curve defined by t_{rr} and I_{RRM}

$$Q_{rr} = \frac{t_{rr} \times I_{RRM}}{2}$$

(5) $di_{(rec)M}/dt$ - peak rate of change of current during t_b portion of t_{rr}

Fig. 12 - Reverse Recovery Waveform and Definitions

20CTH03PbF/20CTH03FPPbF



Vishay High Power Products

Hyperfast Rectifier,
2 x 10 A FRED Pt™

ORDERING INFORMATION TABLE

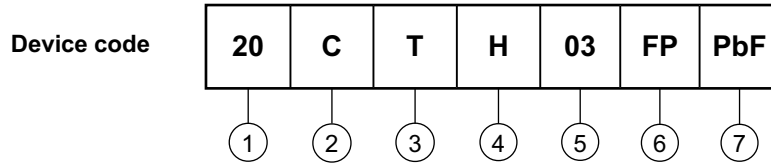

- 1** - Current rating (20 = 20 A)
- 2** - C = Common cathode
- 3** - T = TO-220, D²PAK
- 4** - H = Hyperfast recovery
- 5** - Voltage rating (03 = 300 V)
- 6** -
 - None = TO-220AB
 - FP = TO-220 FULL-PAK
- 7** -
 - None = Standard production
 - PbF = Lead (Pb)-free

Tube standard pack quantity: 50 pieces

| LINKS TO RELATED DOCUMENTS | |
|----------------------------|---|
| Dimensions | http://www.vishay.com/doc?95040 |
| Part marking information | http://www.vishay.com/doc?95042 |



Disclaimer

All product specifications and data are subject to change without notice.

Vishay Intertechnology, Inc., its affiliates, agents, and employees, and all persons acting on its or their behalf (collectively, "Vishay"), disclaim any and all liability for any errors, inaccuracies or incompleteness contained herein or in any other disclosure relating to any product.

Vishay disclaims any and all liability arising out of the use or application of any product described herein or of any information provided herein to the maximum extent permitted by law. The product specifications do not expand or otherwise modify Vishay's terms and conditions of purchase, including but not limited to the warranty expressed therein, which apply to these products.

No license, express or implied, by estoppel or otherwise, to any intellectual property rights is granted by this document or by any conduct of Vishay.

The products shown herein are not designed for use in medical, life-saving, or life-sustaining applications unless otherwise expressly indicated. Customers using or selling Vishay products not expressly indicated for use in such applications do so entirely at their own risk and agree to fully indemnify Vishay for any damages arising or resulting from such use or sale. Please contact authorized Vishay personnel to obtain written terms and conditions regarding products designed for such applications.

Product names and markings noted herein may be trademarks of their respective owners.